

791X40

Hartland | HARTLAND RANGE | Resistive Leading Edge Push On/Off Rotary 2 Way Switching Dimmers

Item Image



Wiring

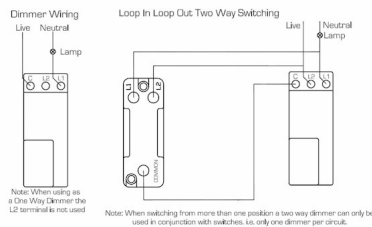



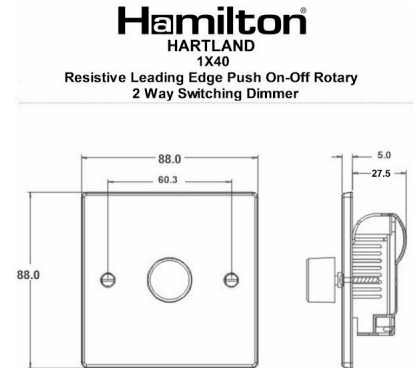



Dimensions



Primary Range	Hartland
Insert Type	1 gang 400W Resistive Leading Edge Push On/Off Rotary 2 Way Switching Dimmer
Insert Colour	Antique Brass
EAN13 Barcode	5017503299416
Commodity Code	85365015
Luckins TSI	386903656
Dimensions(Nominal)	Single: Height = 88.0mm Width = 88.0mm Depth = 5.0mm
Weight	139 GR
Switched Poles	Single
Current Rating	1.66 Amp
Voltage	230V AC
Maximum Load	400W resistive Max Load
Mains Frequency	50Hz
IP Rating	IP2XD
Contact Gap Minimum	N/A
Terminal Capacity 1	2x1mm ²
Terminal Capacity 2	2x1.5mm ²
Earth Terminal Capacity 1	5x1mm ²
Earth Terminal Capacity 2	4 x 1.5mm ²
Earth Terminal Capacity 3	3 x 2.5mm ²
Earth Terminal Capacity 4	1 x 4mm ² Multi-strand
Earth Terminal Capacity 5	1 x 6mm ²
Product Class 1	Face plate must be earthed
Ambient Operating Temperature	-5° to +40°C
Recommended Location	Internal Use Only
Maximum Installation Altitude	2000m
Standard/Approval	BS EN 60669-2-1

791X40

Hartland | HARTLAND RANGE | Resistive Leading Edge Push On/Off Rotary 2 Way Switching Dimmers

<p>Additional Notes</p>	<p>Tungsten filament GU10 lamps must be branded with a fuse base. When using mains voltage halogen lamps- dimmers should be de-rated by 25%. When dimming LED lamps de-rated by 75% - please contact our Technical for compatibility.</p>	
<p>All products listed conform to current British or European standard and the product information is correct at the time of going to press.</p>	<p>All accessories are manufactured under an accredited BS EN ISO 9001 : 2015 Quality Management System.</p>	<p>It is the policy of the company to improve products as part of our development programme. Therefore, we reserve the right to alter designs and dimensions without prior notice.</p>
<p>Illustrations and diagrams are reproduced within the limitations of reproduction and printing process and are not binding.</p>	<p>Due to manufacturing processes we cannot guarantee an exact colour match and shadings of of certain finishes.</p>	<p>Correct as at 17 January 2021 03:35 PM E&OE</p>
<p>R Hamilton & Co Ltd, Unit 10 Carrick Business Centre, 4-5 Bonville Road, Brislington, Bristol, BS4 5NZ T: +44 (0)1747 860088 F: +44 (0)1179 710414 E: info@hamilton-litestat.com www.hamilton-litestat.com Registered Office 1 Rushmills, Bedford Road, Northampton NN4 7YB Registered in London No. 941624 VAT Registration No. 222 6607 84</p>		  <p>Listed in  LUCKINS</p>    <p>CEC No. 1981138</p>
<p>791X40 - Hartland Antique Brass 1x400W Resistive Leading Edge Push On-Off Rotary 2 Way Switching Dimmer Antique Brass</p>		